

“LUNA SLOT” SYSTEM

SYSTEM TYPE:

- Hidden anchors

CLADDING SLABS TYPOLOGY:

- Ceramic tiles, simple or multi-layer;
- Laminate boards or tiles;
- Fibrocement boards or tiles;
- Thin stone tiles, simple or multi-layer.

WORKING ON TILES:

- slot on the horizontal tile edges

SYSTEM COMPONENTS:

The “LUNA Slot” hidden system is made of these components:

- extruded profile type “L8” in aluminium alloy EN 6060 T5 (or similar, when needed), cut on pieces;
- hooks type T6/V3dx” and “T6/V3sx in stainless steel EN 1.4310 (AISI 304);
- standard supporting L brackets type, “A13” and “B13”, in aluminium alloy EN 6060;
- nuts and bolts to fix “L8” profile on the brackets, in stainless steel, class A2;
- anchors to fix the brackets on the wall, mechanical or epoxy-resin based, as needed;
- neoprene gasket strips, to gauge the tiles, the hooks and the aluminium profile, in different thickness, as needed;

SYSTEM DESCRIPTION:

The installation of this system provides the installation of L brackets, together with pieces of vertical rail “L8”, which are placed on the wall, with a pace depending on the slabs width and the vertical joint between the slabs. In case of very large slabs, the installation should provide also insertion of other vertical rail, cut on pieces, based on appropriate project.

The “L8” profile is designed and shaped in order to fit without drillings the following components:

- the L brackets supporting the mullions on the wall, put in place with their design pace;
- the hooks type T6/V3dx” and “T6/V3sx to support the tiles.

The tiles are supported by the hooks T6/V3; they have to be inserted in the proper groove of the vertical profile, put in place with a pace depending on the tiles high and the design horizontal joint;

At the beginning of the tile installation, the starting hooks, which carry the tile, need to have one screw to block the hooks on the “L8” profile.

This arrangement of the components protects the coatings (oxidation or painting) from corrosion and assure to the structure a longer lifetime.

The main characteristic of this “LUNA Slot” hidden system is that each tile must have a slots in the superior and inferior edge, so that the hooks can insert into the slots and are not visible from outside the façade.

Each tile is solidarized with the hooks and the vertical profile using neoprene gasket strips of useful thickness and silicon drops, when needed.

When all the components are put in place, each tile can be set up or dismantled one at a time.

The supporting structure makes possible any type of regulation and it is able to protect from wind action and to allow the thermal expansion of all the components.

SYSTEM SIZE:

- The standard distance between the wall and the back side of the panels is 128 mm, with a standard regulation of ± 25 mm.
- The standard thickness of the slabs for this system is from 11 to 20 mm

Here you can find a standard details of the system.

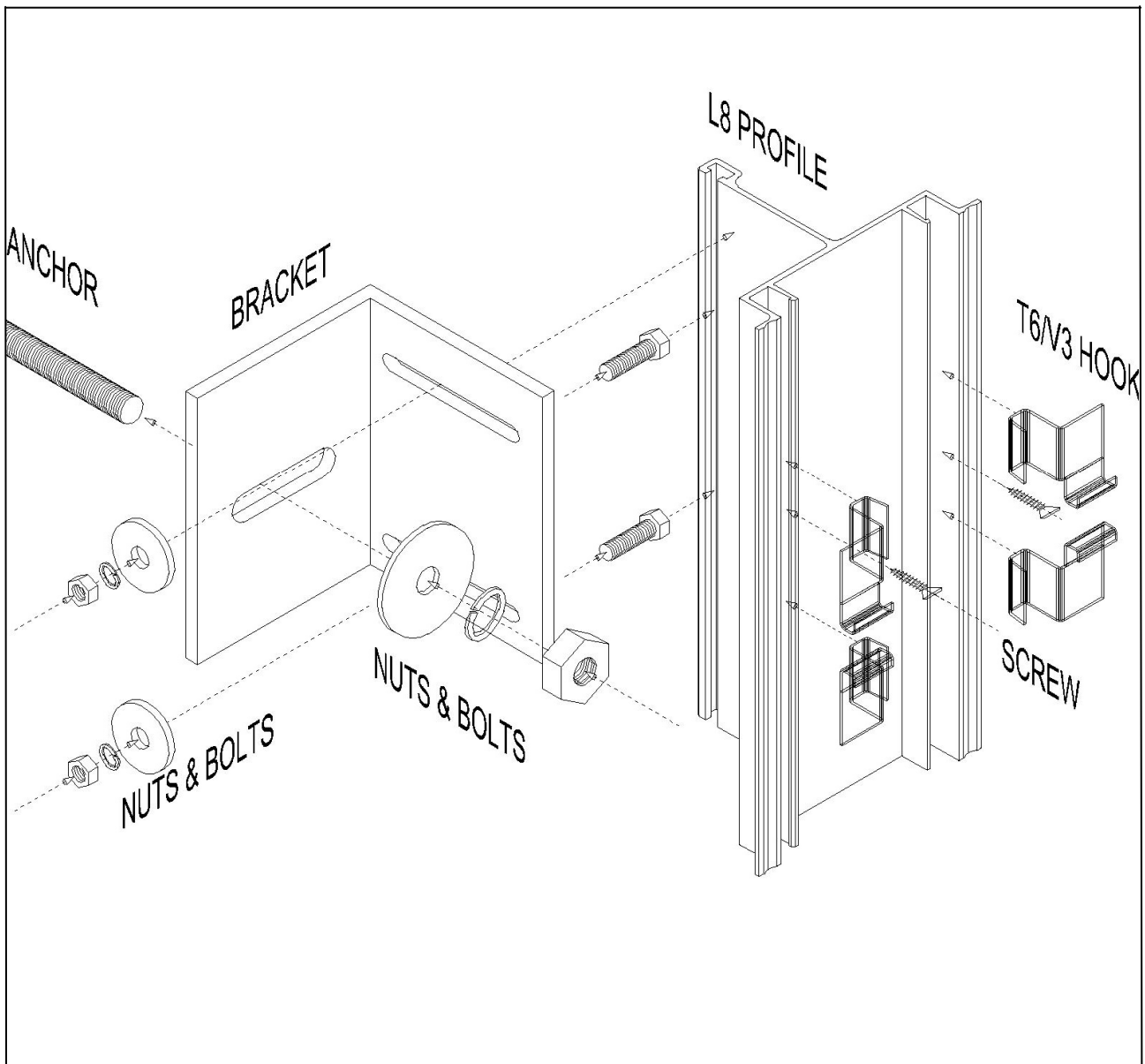

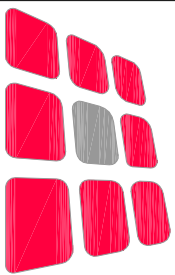

DALLERA
Tecnologie S.r.l.

Società unipersonale

Via Trivulzina, 13/48 - Pad. 20 - 20864 Agrate Brianza (MB)

Tel. 039 9711592 - Fax 039 9711593

www.dalleratecnologie.com info@dalleratecnologie.com

"LUNA Slot" SYSTEM

STANDARD COMPONENTS

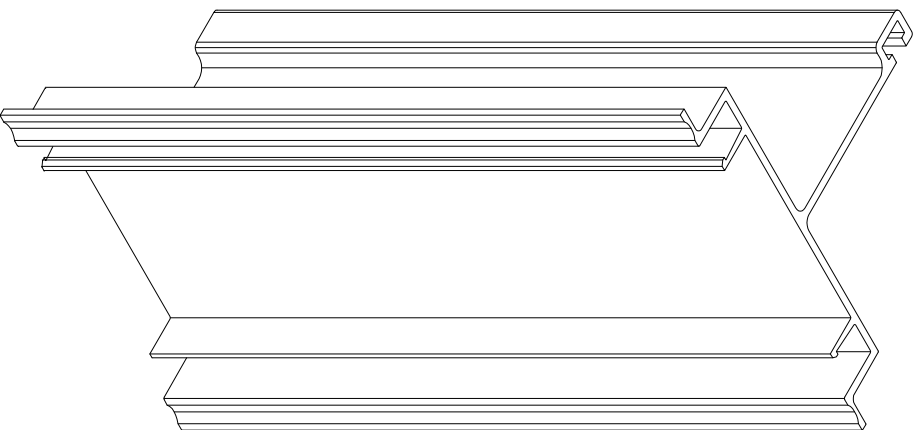

L8 PROFILE

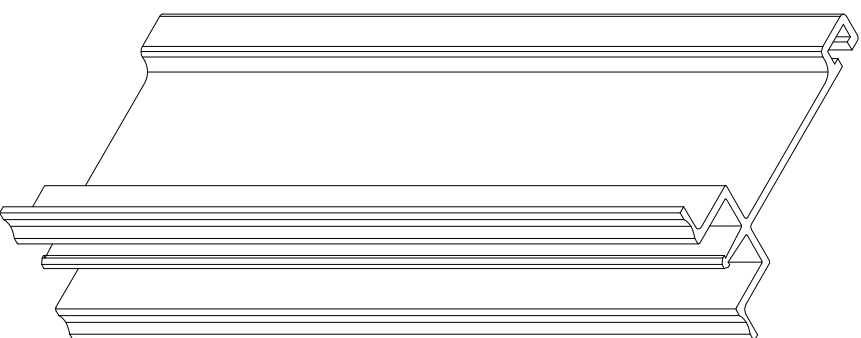

L1 PROFILE

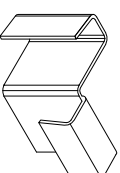

T6/V3 (dx e sx) hooks

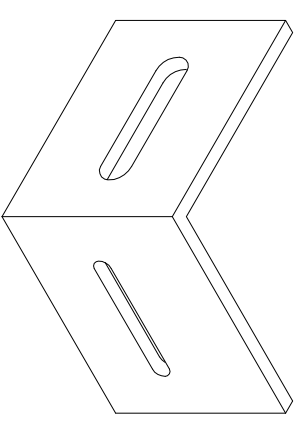

BRACKET

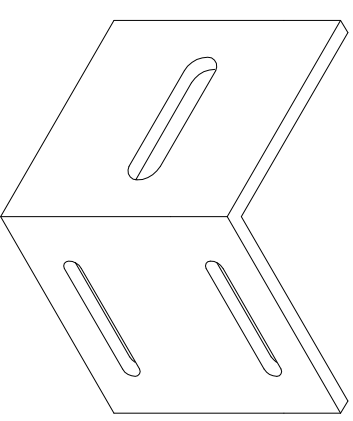

DOUBLE BRACKET

"LUNA Slot" SYSTEM

STANDARD DETAIL FOR
FACADE TOP

vertical cross-section - SCALE 1:2

TOP TIN-PLATE

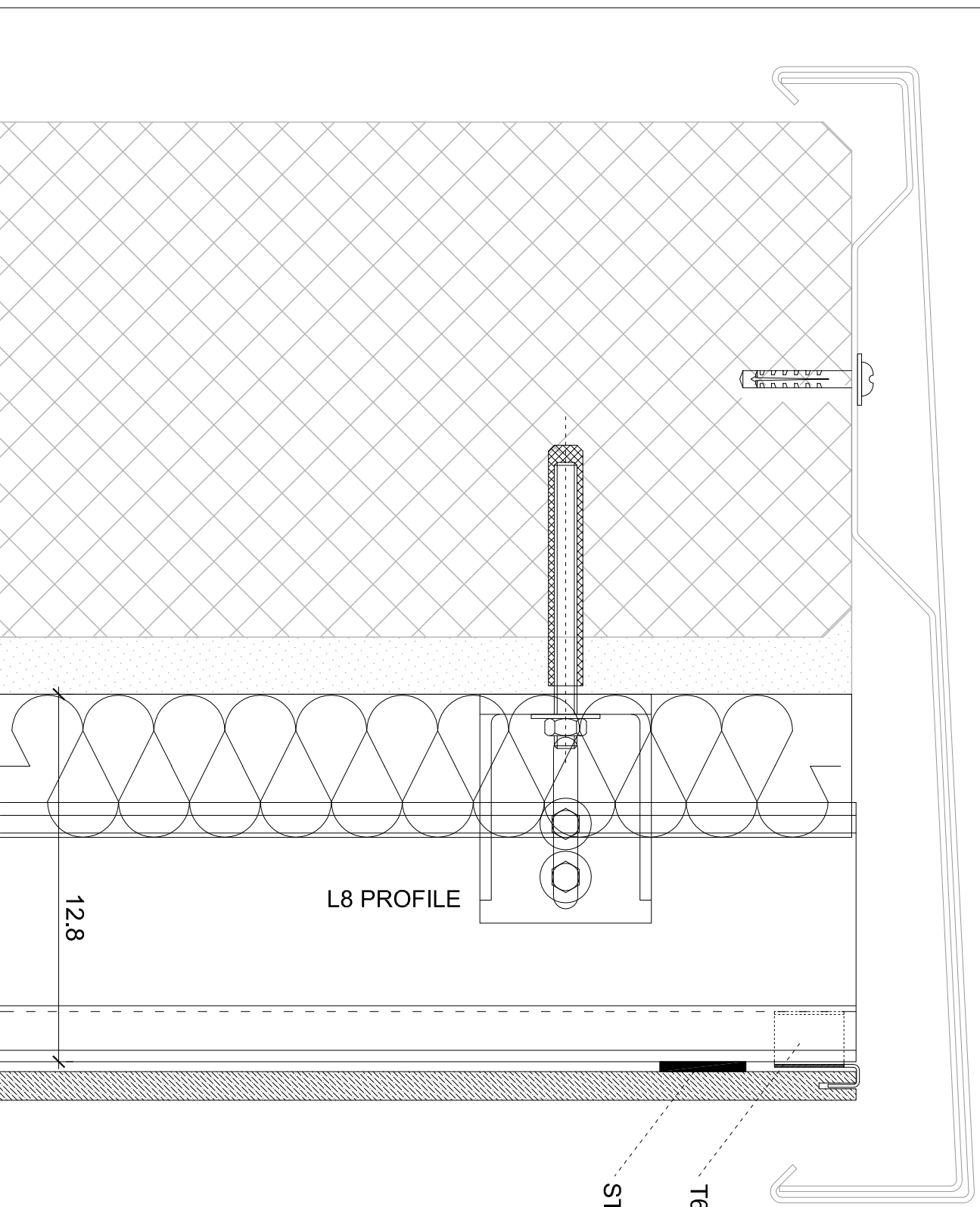

L8 PROFILE

12.8

T6/V3 HOOK
STRUCTURAL ADHESIVE

"LUNA Slot" SYSTEM

STANDARD DETAIL FOR

HORIZONTAL JOINT

vertical cross-section - SCALE 1:2

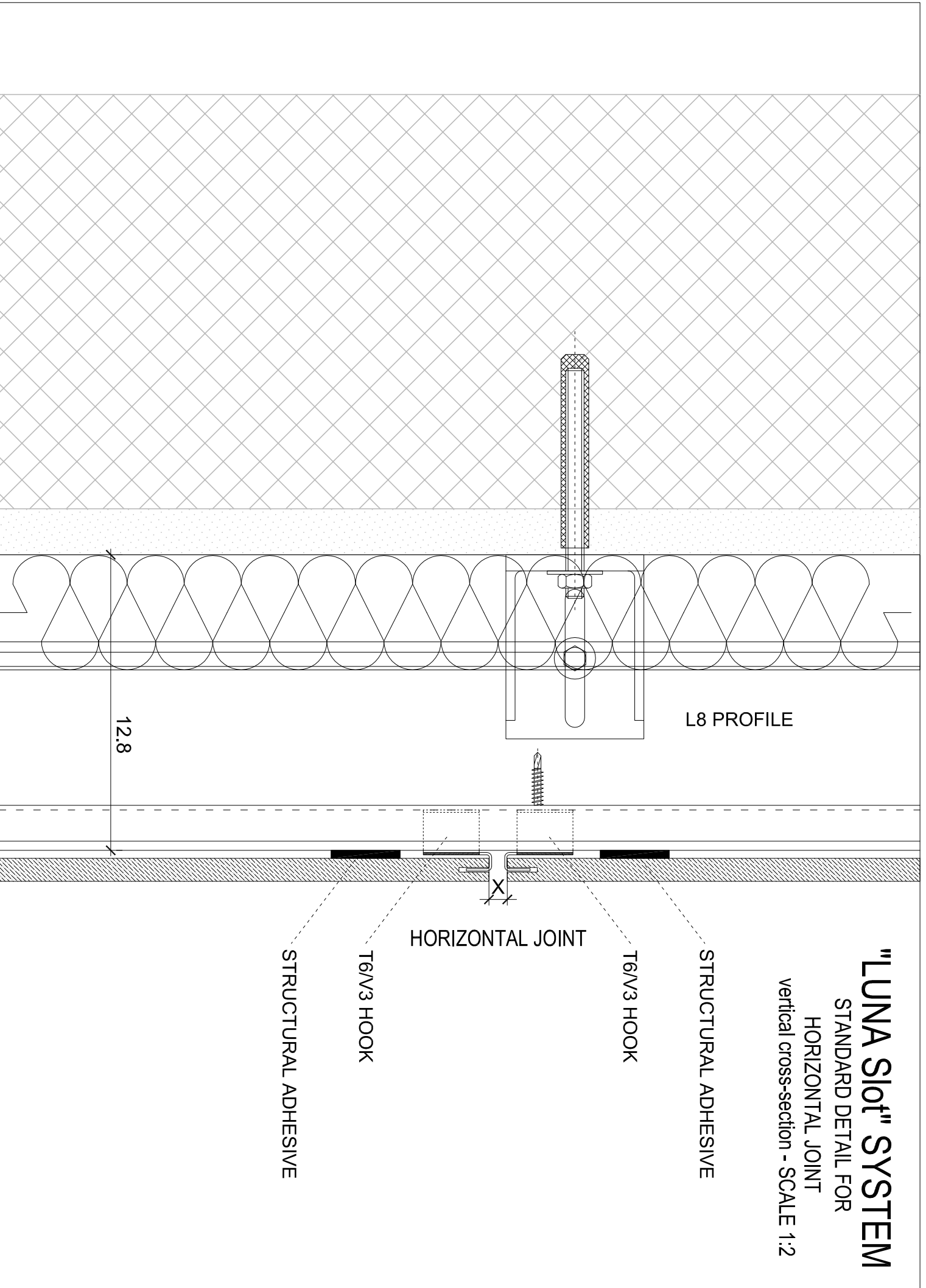

"LUNA Slot" SYSTEM
STANDARD DETAIL FOR
GROUND LEVEL
vertical cross-section - SCALE 1:2

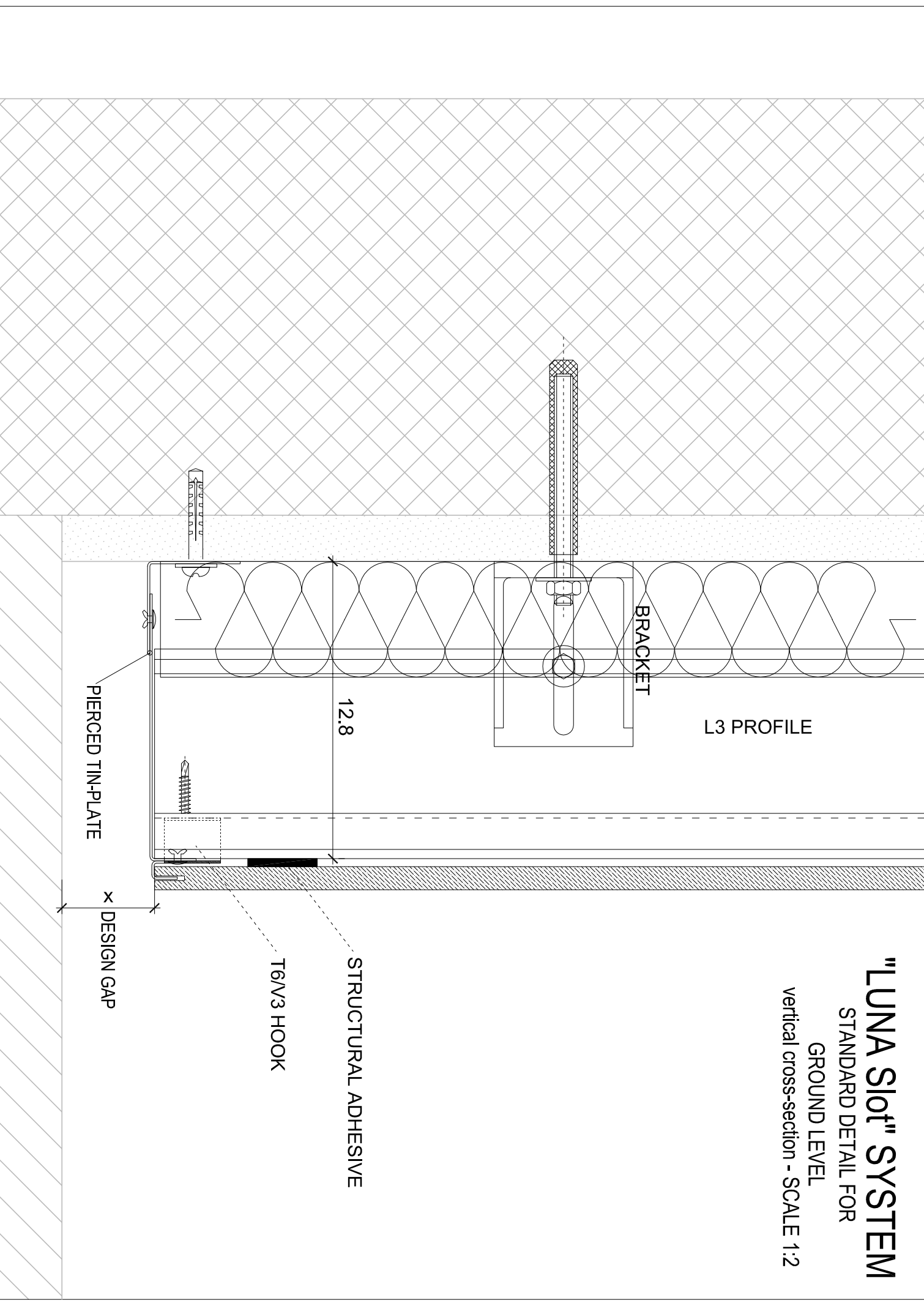

L3 PROFILE

BRACKET

12.8

STRUCTURAL ADHESIVE

T6/V3 HOOK

PIERCED TIN-PLATE

x DESIGN GAP

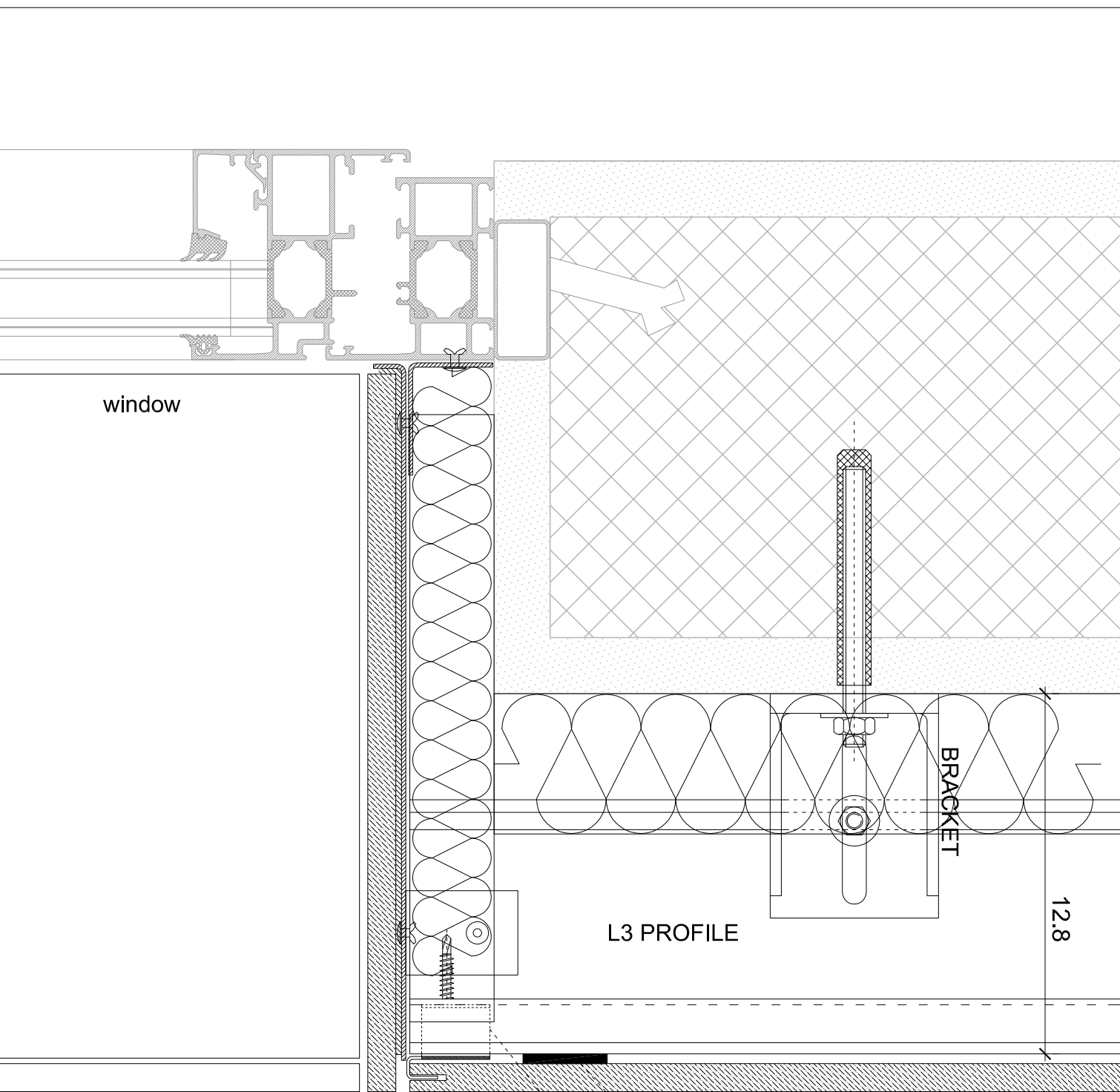

"LUNA Slot" SYSTEM

STANDARD DETAIL FOR
 WINDOW INTRADOS
 vertical cross-section - SCALE 1:2

STRUCTURAL ADHESIVE

T6/V3 HOOK

L3 PROFILE

BRACKET

12.8

window

"LUNA Slot" SYSTEM
STANDARD DETAIL FOR
WINDOW SILL
vertical cross-section - SCALE 1:2

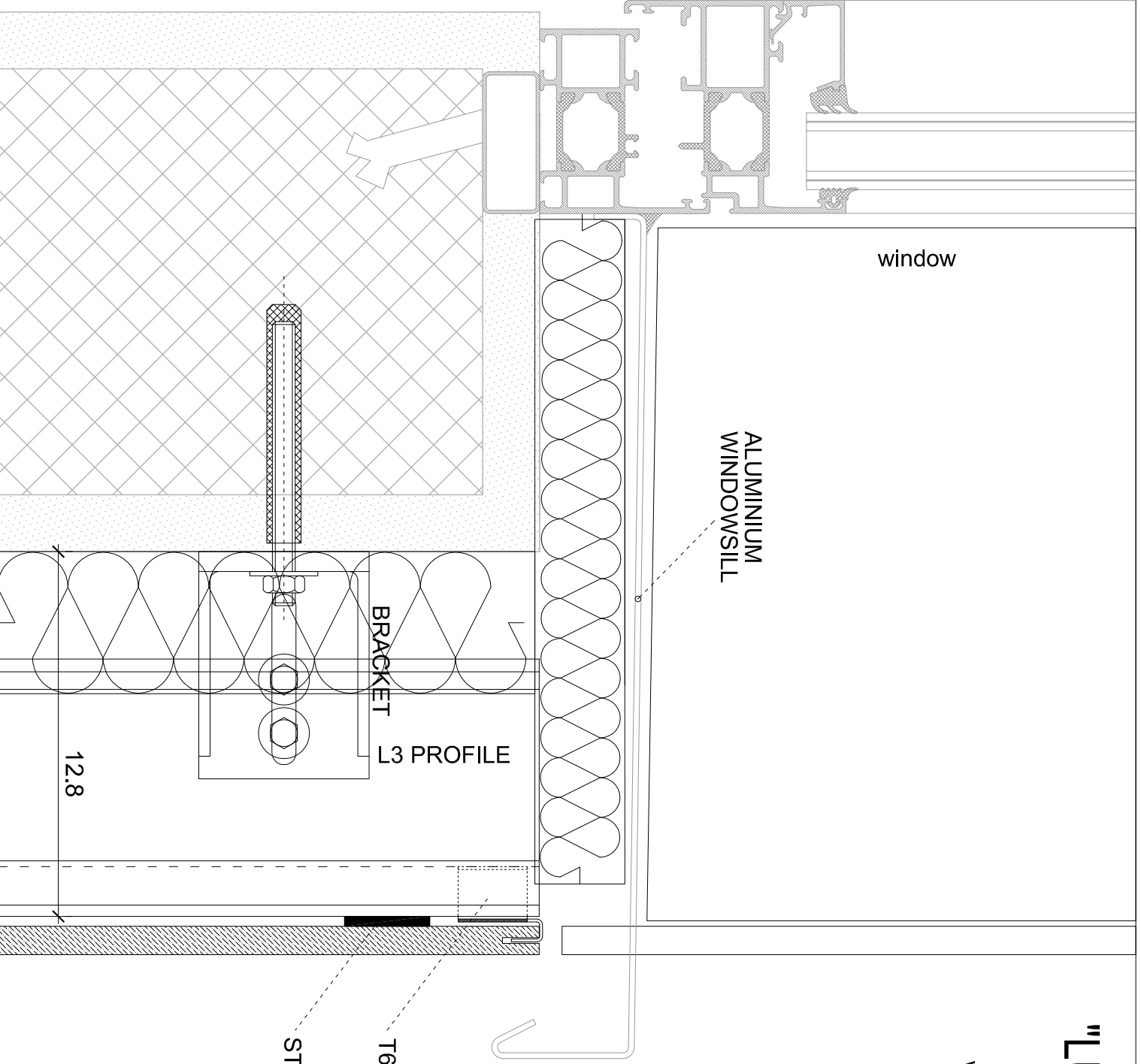

"LUNA Slot" SYSTEM

STANDARD DETAIL FOR

WINDOW REVEAL

horizontal cross-section - SCALE 1:2

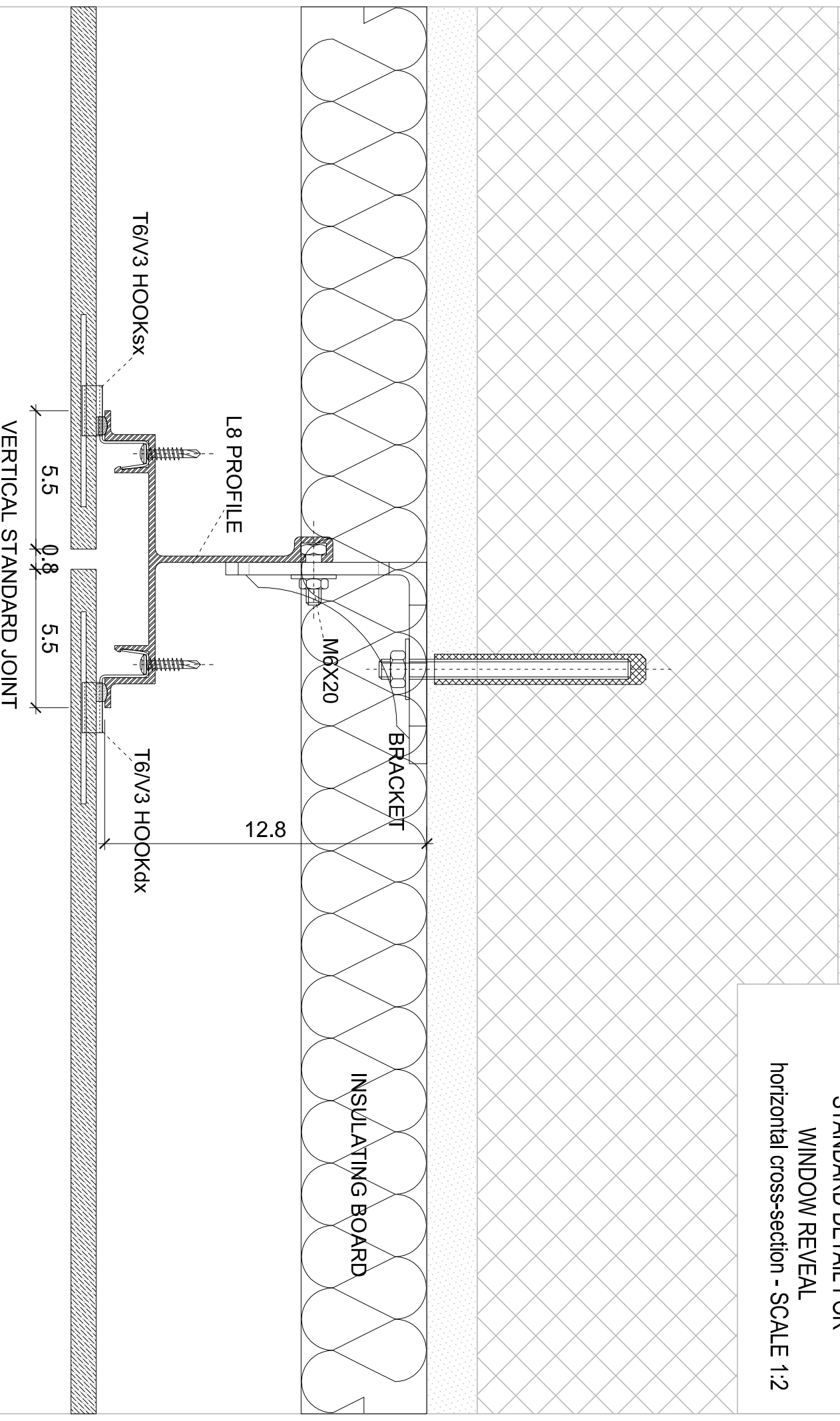

"LUNA Slot" SYSTEM

STANDARD DETAIL FOR

END CORNER

horizontal cross-section - SCALE 1:2

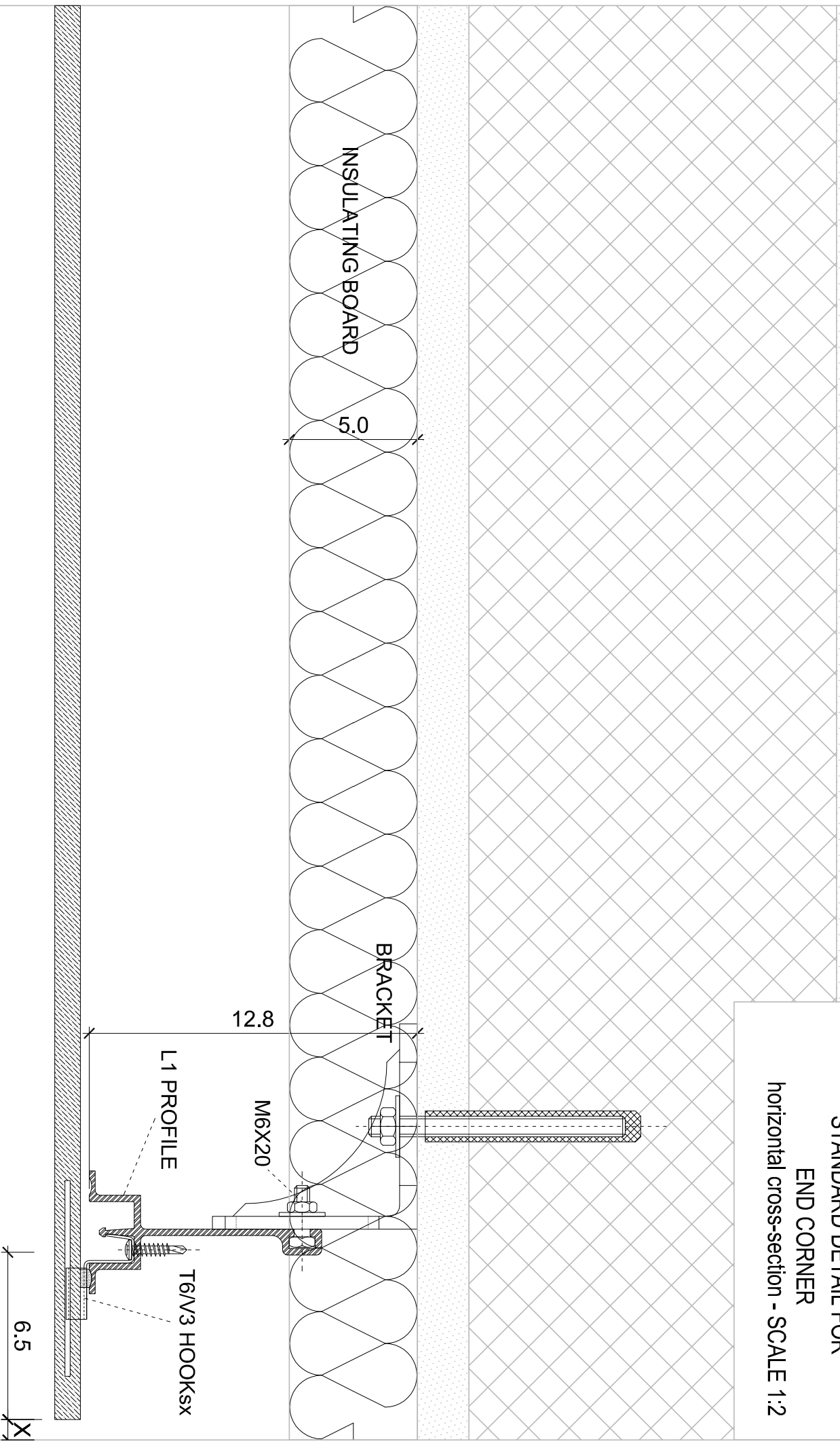

"LUNA Slot" SYSTEM
STANDARD DETAIL FOR
INTERNAL CORNER
horizontal cross-section - SCALE 1:2

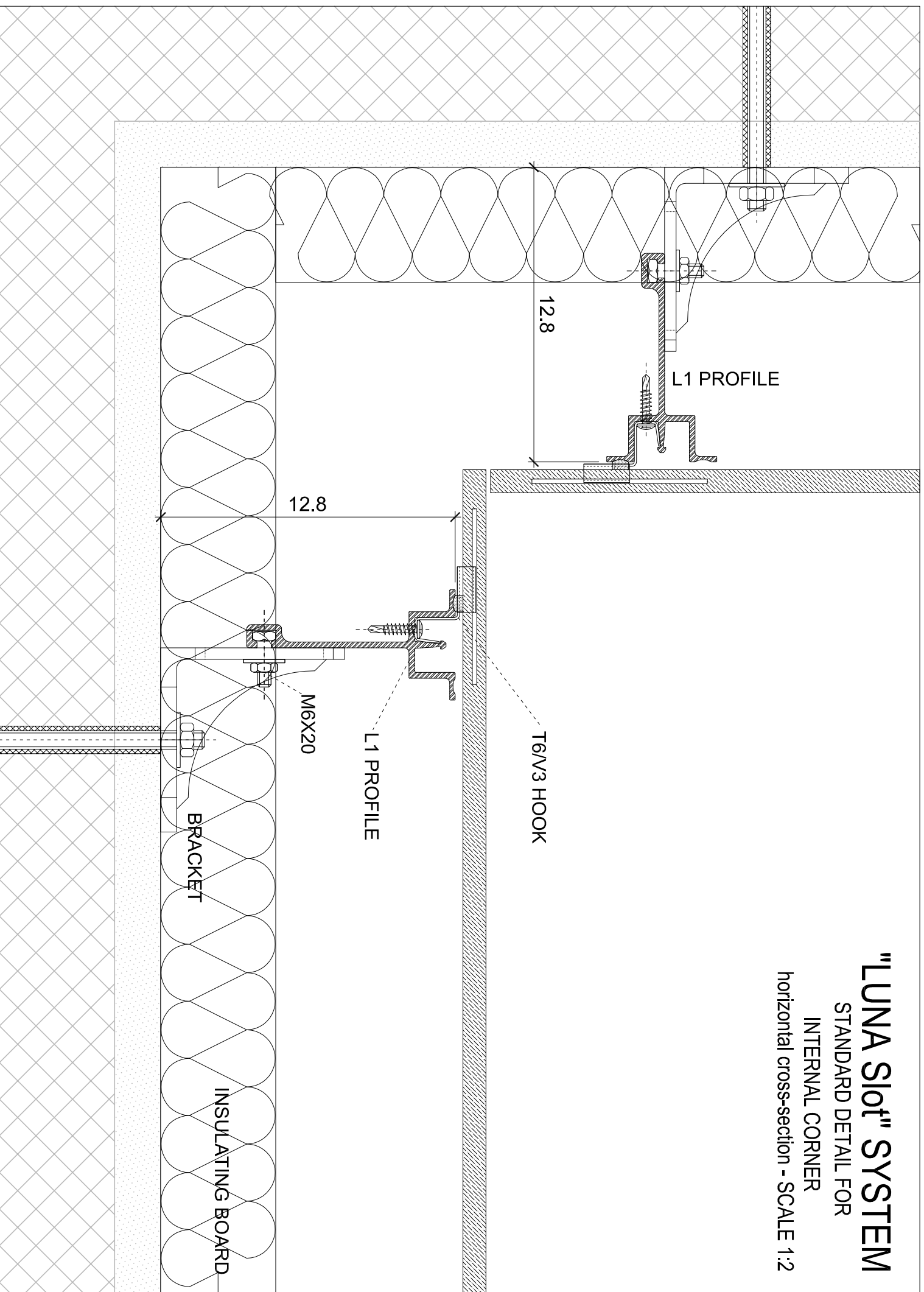

"LUNA Slot" SYSTEM

PANEL SET-UP
vertical cross-section - SCALE 1:2

